

Key Features

- **FAST, SMOOTH AND PRECISE CONTROL**
From smart digital circuit and proportional servo valve.
- **SIMPLE TIME SAVING FIELD SETUP**
Pushbuttons with LED feedback allow easy ranging and tuning, sense reversal and linear/non-linear characterisation, plus auto-ranging function and reset-to-default facility.
- **QUICK AND EASY TUNING**
Allows optimisation of sensitivity while maintaining stability and avoiding overshoot
- **LOOP POWERED - NO SEPARATE POWER NEEDED**
Just 4-20mA signal plus air supply.
- **INTRINSICALLY SAFE APPROVED OPTIONS**
ATEX approved version for use in hazardous zone 0 areas when used with a suitable electrical barrier.
- **UNIVERSAL APPLICATION**
Use with any quarter-turn or linear actuator, simple or double acting.
- **WIDELY ADJUSTABLE RANGE**
Span from 30° upwards (for positioner and for optional angle retransmit) may be set anywhere within the 100° range.
- **INTEGRAL OPTIONS - EASILY RETROFITTED MODULES INSIDE BOX**
 - 2 wire 4-20 mA angle retransmit - fully isolated from positioner loop.
 - 2 limit switches or proximity sensors.
 - High visibility Clear Cone position monitor.
 - DIN plug connectors.
- **ROBUST WEATHERTIGHT METAL HOUSING**
Epoxy painted for harsh industrial environments, sealed to IP65/NEMA 4.
- **BACKLASH FREE MECHANISM - FEW MOVING PARTS**
Well proven, low wear, low maintenance device.
No gears or levers on pot drive.
- **ZERO EFFECT OF SUPPLY AIR PRESSURE FLUCTUATION**
No positioner movement if pressure changes within operating range.
- **INSTALLATION ADAPTABILITY**
May be mounted to any actuator using VDI/VDE 3845 Namur drive option, or via Kinetrol male square and mount bracket, or via direct mount with integral porting to a Kinetrol actuator.
- **VISUAL POSITION INDICATION**
External pointer/scale or high visibility Clear Cone monitor, plus internal scale for setup.
- **VIBRATION AND SHOCK RESISTANT**
Low mass spool and balanced pilot mechanism allow up to 4G vibration tolerance.

EL Digital Positioner

DIMENSIONS

EL Positioner shown direct mounted on a Kinetrol 05 Actuator

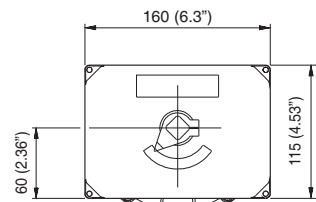

Air Inlet Port:
ISO & DIN models G¹/₈"
ANSI models 1/4" NPT

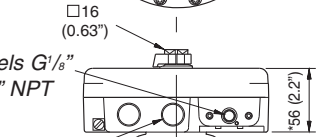

2 Conduit Entries:
ISO models M20
ANSI models 1/2"x14 NPS

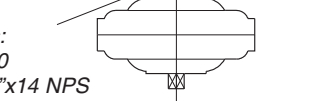

Actuator Model	* Additional Adaptor Dim.	Additional Adaptor Weight
12	15.0 (0.59")	0.65 kg/1.4lbs
14	18.0 (0.71")	0.65 kg/1.4lbs

NAMUR Discrete Version

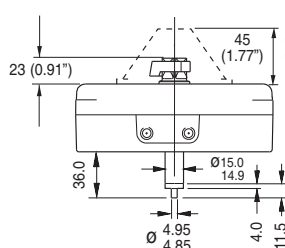

4 Mount Holes:
M6 x 5 deep equi-spaced on 50 PCD

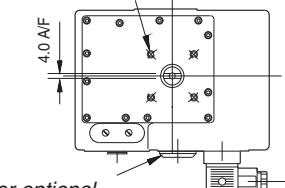

Entry for optional Limit Switch (shown plugged)

External Actuator Ports

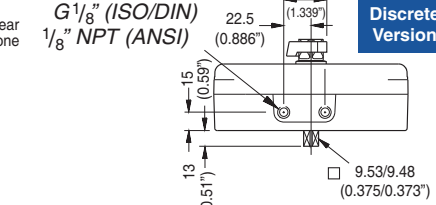

Kinetrol Discrete Version

When drawing information is not given - It is the same for both versions

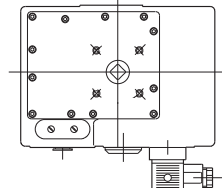

DIN Plug options - shown 90° out of true position
ISO/DIN models Pg 11 cable gland (8 to 10mm dia)
ANSI models 1/2" NPT cable entry (for use with flexible conduit).

SPECIFICATION

Air Supply	instrument quality (dry, clean, oil free) 3.5 to 7.0 bar, 50 to 100psi Contact Kinetrol for 5µm inlet air filter option	Deviation from linearity	less than 0.7% of span
Signal	4-20mA, requiring max 8V to drive through positioner circuit (compatible with standard 24V DC source)	Operating temperature range	-20°C to +70°C (-4°F to 160°F)
Control Response	0-90 degree positioning, with eleven preselected characteristics (standard). Consult Kinetrol for the following versions i) linearisation of butterfly valve characteristics ii) pre-selected travel time extension options. iii) customised responses	Flowrate	3.3 scfm / 93 l/min @ 5.5 barg
Sensitivity	better than 0.1mA	Adjustments (push buttons)	low & high points (define range), proportional gain, velocity proportional setpoint advance (damping)
Hysteresis	less than 0.7% of span	Hazardous area option (ATEX):	II IGD Eex ia II CT4 (-20°C ≤ Ta ≤ +70°C) Note: Limited to non-conductive dusts
Repeatability	better than 0.7% of span	Weight	2.95 kg/6.5 lb
		Materials	case and cover - zinc alloy spool valve and liner - stainless steel
		Finish	epoxy stove enamel

ORDERING CODES

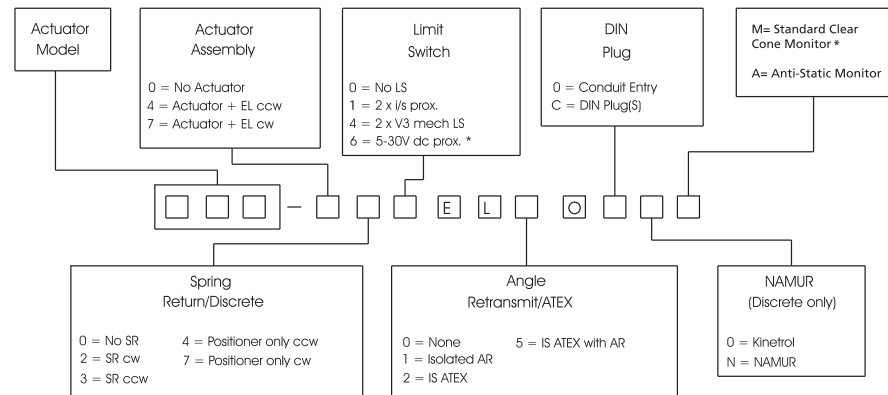

Examples:
000-040EL000N
= discrete ccw EL with NAMUR drive

050-404EL0000M
=ccw EL on 050 actuator + LS + Clear Cone Monitor

Counter clockwise (ccw) on rising signal is determined looking down on positioner.

* not available on IS version

The policy of KINETROL is one of continuous improvement. We reserve the right to alter the product as described and illustrated without notice.

KINETROL

Kinetrol Ltd, Trading Estate, Farnham, Surrey GU9 9NU, England
Telephone: 01252 733838 Fax: 01252 713042
e-mail: sales@kinetrol.com

KF 372 11/08

KINETROL

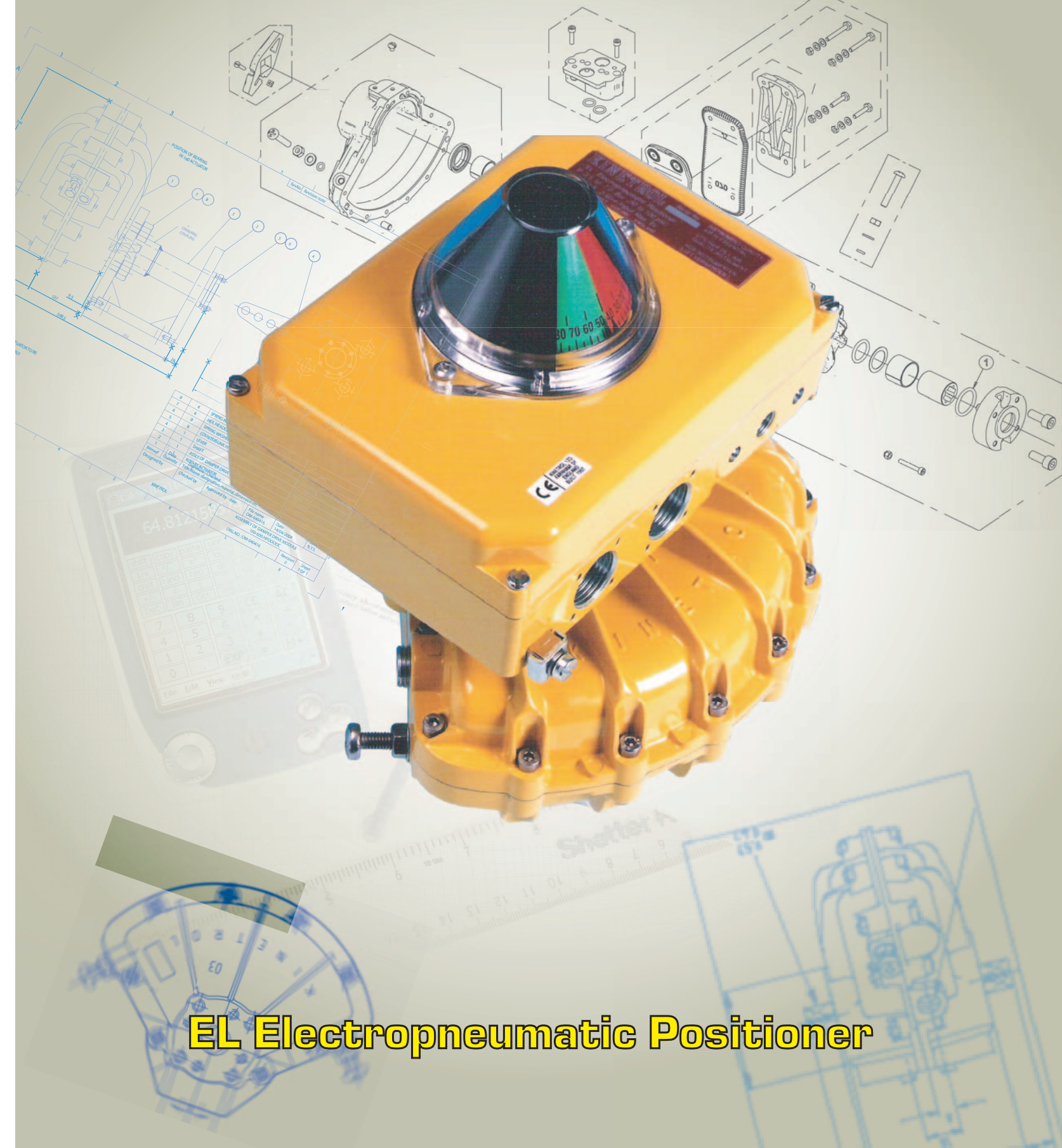

EL Electropneumatic Positioner

EL Electropneumatic positioner

The EL electropneumatic positioner combines the precision and adaptability of a digital electronic control circuit with the smoothness and efficiency of Kinetrol's proven proportional servo valve, to give the best available 4-20mA positioning performance from rotary pneumatic actuators. This unbeatable performance is combined with the easiest available setup procedure, easiest access to all functions and options, easy connectivity, and a truly compact all-metal enclosure, plus unique easy-set isolated angle retransmit and limit switch options inside the same enclosure.



LID - shown with optional Clear Cone angle monitor. Epoxy coated die-cast metal, held on by four captive screws - gives quick access to the interior.

CARRIER PLATE ASSEMBLY - integrated assembly carrying the positioner circuit, feedback pot, pot drive, feedback shaft, external connector blocks, all internal wiring, plus optional angle retransmit circuit and limit switches. Easily removed for mounting, conversion, or maintenance.

OPTIONAL LIMIT SWITCHES - V3 mechanical type or inductive proximity sensors, activated by easy-set cams. Wired via full size robust connector blocks.

FEEDBACK POT DRIVE - zero backlash, proven trouble-free for life.

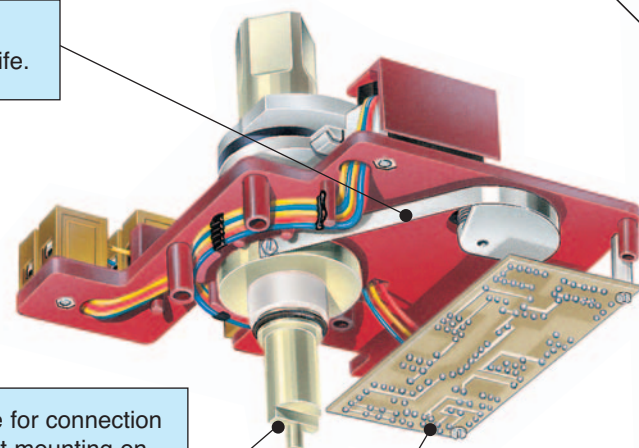

FEEDBACK SHAFT - quick-fit interface for connection to actuators - range of options for direct mounting on Kinetrol vane-type actuators, Namur industry standard interface (shown here) for use with any brand of actuator via standard mount kits or male square for other rotary / linear applications.

OPTIONAL ANGLE RETRANSMIT CIRCUIT - loop powered linear 4-20 mA, 14-30 V DC supply range, rangeable down to 30 degrees for full 4-20mA span. Easily retrofittable, electrically isolated from positioner signal loop.

FEEDBACK POT - high quality conductive plastic servo-type with ball bearings. Proven long life and high precision.

AIRFLOW CHANGEOVER BLOCK - allows selection of direction in which positioner moves on loss of signal.

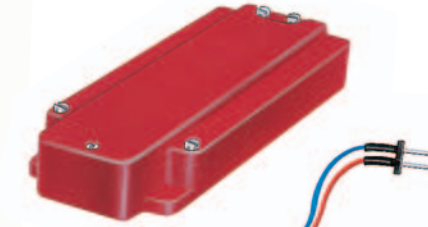
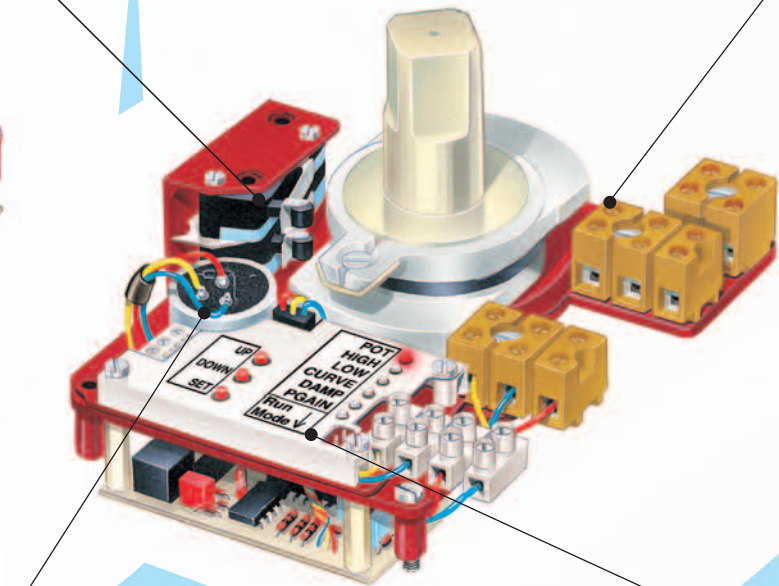

SERVO VALVE - unique electromagnetic torquemotor mechanism pushes on flapper nozzle to produce pilot air pressure which positions 5-port all-metal spool valve proportionally to the signal sent to it by the positioner circuit. The control air (below) is completely separated from the electromagnetic mechanism (above) by seals to maximise reliability. A constant flow valve device prevents any effect of supply pressure variation on spool position. Integrated unitary design - easily removable.

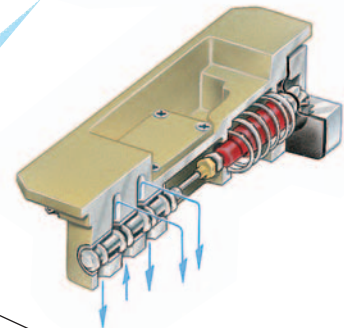

DIGITAL POSITIONER CIRCUIT - miniature 4-20mA loop-powered microprocessor based circuit, with three setup pushbuttons and six LED indicators. Easy to set for all likely ranges, including reversal of direction of movement on rising signal. Standard with ten user-selectable non-linear characteristics plus one linear. Versions providing (i) a range of flow linearising algorithms to compensate for the installed characteristics of butterfly valves with different pressure drops, (ii) a selection of pre-programmed travel time extension options or (iii) any desired non-linear characteristic available by order. Adjustable proportional gain and damping settings allow optimum tuning for any actuator/load combination. Self-ranging routine will find physical endstops and fit desired signal range between them.

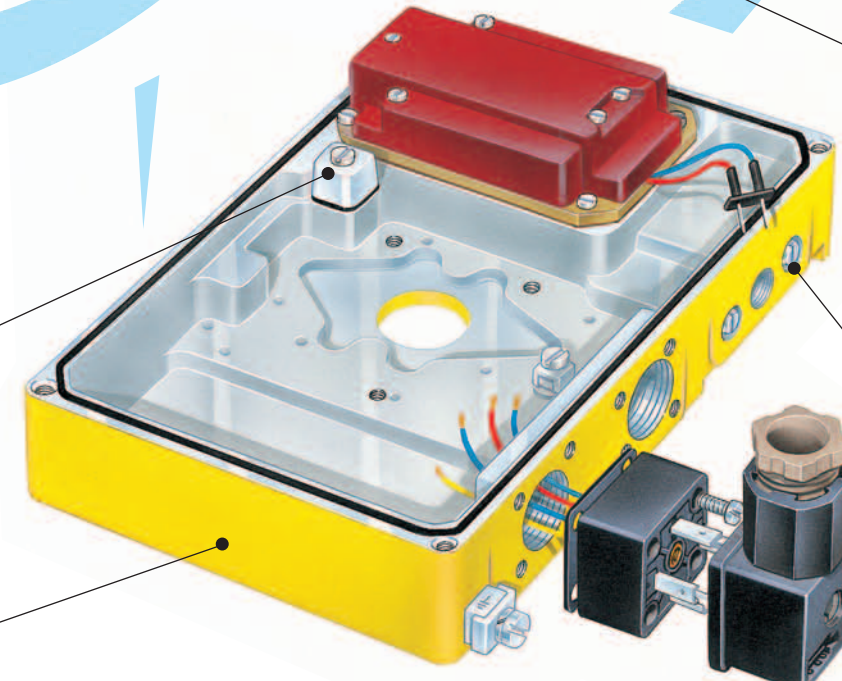

EXHAUST SNUBBER SCREWS - allow travel speed reduction down to 1/3 x full speed independently in the two directions, by screwing in to restrict exhaust air flow.

ENCLOSURE - robust die-cast metal, with tough corrosion-resistant epoxy coating, and O-ring sealing to IP65 / NEMA 4 standard. Layout gives access to all adjustments immediately on removal of lid.

OPTIONAL 4-TERMINAL DIN PLUGS - available on both signal and limit switch connections (only signal shown here). Allows fully external connection with rapid connect / disconnect capability. Retrofittable to conduit entry models.

OPERATING PRINCIPLES

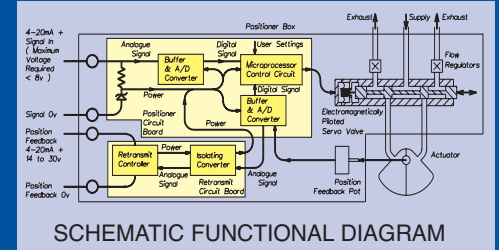

- The EL positioner is designed to drive a rotary or linear actuator to a position set by the 4-20 mA input signal, and then hold it there until the signal changes.

- The microprocessor in the loop powered 4-20 mA positioner circuit reads the signal via one channel of a 12-bit A-D converter, reads the position voltage from the feedback pot via the second channel of the A-D converter, and compares the two. If it detects a position different from that required by the signal, it changes its output to the servo valve in order to drive the actuator in the direction required to reach the correct position. As the actuator moves, the feedback pot voltage changes, and the microprocessor continually calculates how to adjust the servo valve in order to guide the actuator accurately into position. Because the servo valve is a fully proportional device, it can be adjusted precisely and smoothly to slow the actuator to a stop exactly where it should be. The microprocessor is programmed with a sophisticated but compact algorithm which allows this critical dynamic valve adjustment to be made correctly to give optimal results with any actuator/load combination - slow or fast, low friction or high friction, low inertia or high inertia, all can be optimised by tuning the PGAIN and DAMP parameters via the positioner circuit pushbuttons. The 12-bit A-D conversion gives resolution of about 1/40 degree.

- The relationship between the input signal and desired position (the "characteristic") is stored in the microprocessor's memory. It can be set to follow any one of eleven pre-programmed curves between its two endpoints. The endpoints (each a combination of a signal value and a position) are set by the user via the pushbuttons. One of the eleven curves is a linearly proportional characteristic - this characteristic only can be selected to give movement of the actuator for signals extrapolated below the low endpoint and above the high endpoint, or to stop dead on signals below the low and above the high endpoint. The "stop dead" behaviour is the only option for the other ten non-linear curves.

- The settings entered by the user are stored in non-volatile memory, and are retained even if power (i.e. signal) is lost.

