



I Application

The INNOVA N-type valve is a pneumatic shut-off seat valve for hygienic applications.

I Design and features

- Hygienic design according to EHEDG
- Gasket with specific profile guarantees reliability under adverse working conditions.
- Hygienic design of the gasket ensures optimal cleaning.
- Single-acting pneumatic actuator.
- Normally closed valve (NC).
- The valve can be changed to normally open (NO) by simply reversing the position of the pneumatic actuator.
- Easy assembly/disassembly of internal parts by loosening a clamp fastener.
- Open lantern allows visual inspection of shaft sealing.
- 360° adjustable body.

I Technical specifications

Materials:		
Parts in contact with the product	AISI 316L (1.4404)	
Other stainless steel parts	AISI 304 (1.4301)	
Gasket	EPDM according to FDA 177.2600	
Surface finish:		
Internal	Bright polish $Ra \leq 0,8 \mu m$	
External	Matt	
Available sizes:		
DIN 11850	DN 25 - DN 100	
ASME BPE	OD 1" - OD 4"	
Connections	Weld	
Operating limits:		
Temperature range	-10 °C to+ 121 °C (EPDM)	14 °F to 250°F
	+140 °C (SIP, max. 30 min)	284 °F
Maximum working pressure	10 bar	145 PSI
Minimum working pressure	Vacuum	
Compressed air pressure	6-8 bar	87-116 PSI

I Options

- Double-acting pneumatic actuator.
- Gaskets: FPM, HNBR.
- Other connection types.
- Control unit: C-TOP and C-TOP+.
- External position sensors.
- Surface finish: $Ra \leq 0,5 \mu m$.



I Housing combinations

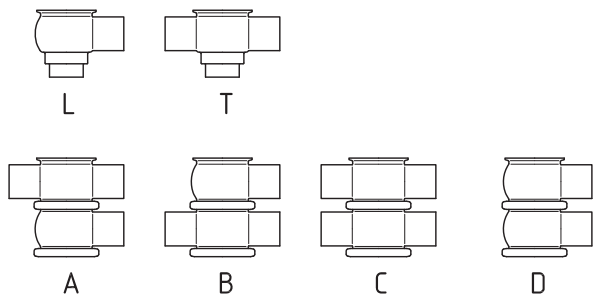

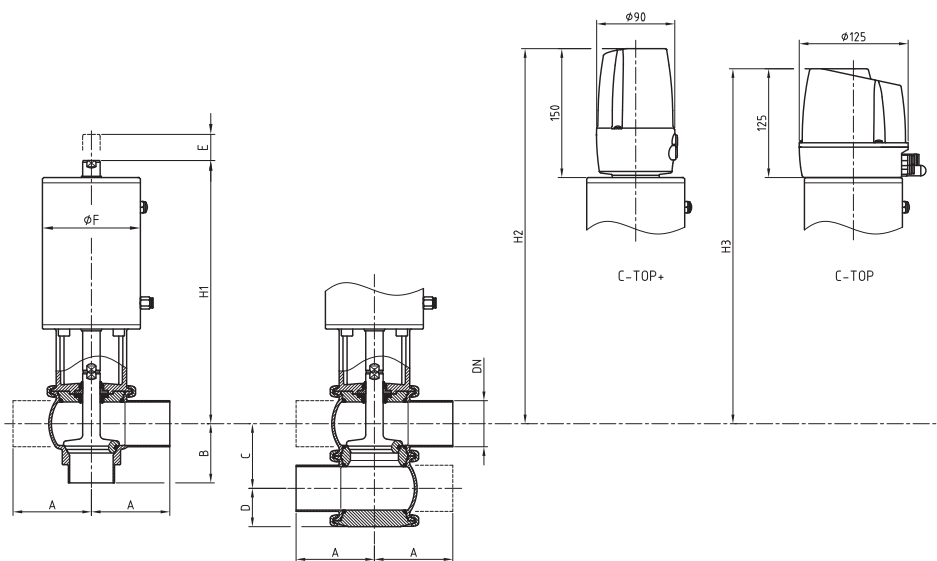

I Dimensions





	DN	Pipe ϕ	A	B	C	D	ϕF	E	H ₁	H ₂	H ₃
DIN	25	29 x 1,5	50	50	50	32	87	15	239	367	342
	40	41 x 1,5	85	60	62	38	87	24	240	377	352
	50	53 x 1,5	90	68	74	44	112	31	302	433	408
	65	70 x 2	110	81	92	53	143	37	348	485	460
	80	85 x 2	125	90	107	60	143	37	355	492	467
	100	104 x 2	150	125	127	70	216	34	383	516	491
OD	1"	25,4 x 1,65	50	50	46	30	87	15	241	369	344
	1½"	38,1 x 1,65	85	60	59	36	87	24	242	379	354
	2"	50,8 x 1,65	90	68	72	43	112	31	304	434	409
	2½"	63,5 x 1,65	110	81	86	50	143	37	351	488	463
	3"	76,2 x 1,65	125	90	99	56	143	37	359	496	471
	4"	101,6 x 2,11	150	125	124	69	216	34	384	517	492

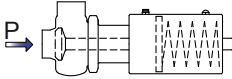

Maximum pressure in bar / PSI without leakage at the valve seat.

Actuator/valve body combination and direction of pressure	Air pressure	Plug position	OD 1"	OD 1½"	OD 2"	OD 2½"	OD 3"	OD 4"
	[bar] / [PSI]		DN 25	DN 40	DN 50	DN 65	DN 80	DN 100
	6 / 87	NC	10 / 145	6 / 87	5,5 / 79	5,5 / 79	4,5 / 65	5 / 72
	6 / 87	NO	10 / 145	9 / 130	6 / 87	6,5 / 94	5,5 / 79	10 / 145
	6 / 87	A/A	10 / 145	10 / 145	10 / 145	10 / 145	10 / 145	10 / 145

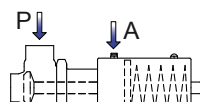
Maximum pressure in bar / PSI against which the valve can open.

Actuator/valve body combination and direction of pressure	Air pressure	Plug position	OD 1"	OD 1½"	OD 2"	OD 2½"	OD 3"	OD 4"
	[bar] / [PSI]		DN 25	DN 40	DN 50	DN 65	DN 80	DN 100
	6 / 87	NC	10 / 145	10 / 145	10 / 145	9,5 / 137	8,5 / 123	10 / 145
	6 / 87	NO	10 / 145	7,5 / 108	10 / 145	9 / 130	10 / 145	6 / 87

A = Air
 P = Product pressure
 NC = Normally closed
 NO = Normally open
 A/A = Double acting

Note: Values for standard actuators.
 For other pressures, bigger actuators can be assembled.

